

# SL6000J-500

型式名 SL6000J

# クローラクレーン

最大定格総荷重500t×6.2m

▶バリエーション .....	1 2
▶主要諸元 .....	3
▶全体図 .....	4
▶能力増大装置付仕様 .....	4
▶仕様とアタッチメント（アタッチメントの互換性） .....	5
▶フック巻上限界 .....	5
▶定格総荷重 .....	6
STANDARD	
▶クローラクレーン作動範囲図 .....	7 8
▶ヘビーデューティ主ブーム定格総荷重表 .....	8
▶ラフティング主ブーム定格総荷重表 .....	9
▶ラフティングブーム補助シーブ定格総荷重表 .....	9
▶ロング主ブーム定格総荷重表 .....	10
▶ロング補助シーブ定格総荷重表 .....	10
▶ラフティングジブ作動範囲図 .....	11
▶ラフティングジブ定格総荷重表 .....	12~15
HEAVY LIFT	
▶クローラクレーン作動範囲図 .....	17,18
▶ヘビーデューティ主ブーム定格総荷重表 .....	18
▶ラフティング主ブーム定格総荷重表 .....	19
▶ラフティングブーム補助シーブ定格総荷重表 .....	19
▶ロング主ブーム定格総荷重表 .....	20
▶ロング補助シーブ定格総荷重表 .....	20
▶ラフティングジブ作動範囲図 .....	21
▶ラフティングジブ定格総荷重表（HLマストポイント半径16m） .....	22~24
▶分解時の寸法・質量 .....	25 26

## ▶ バリエーション

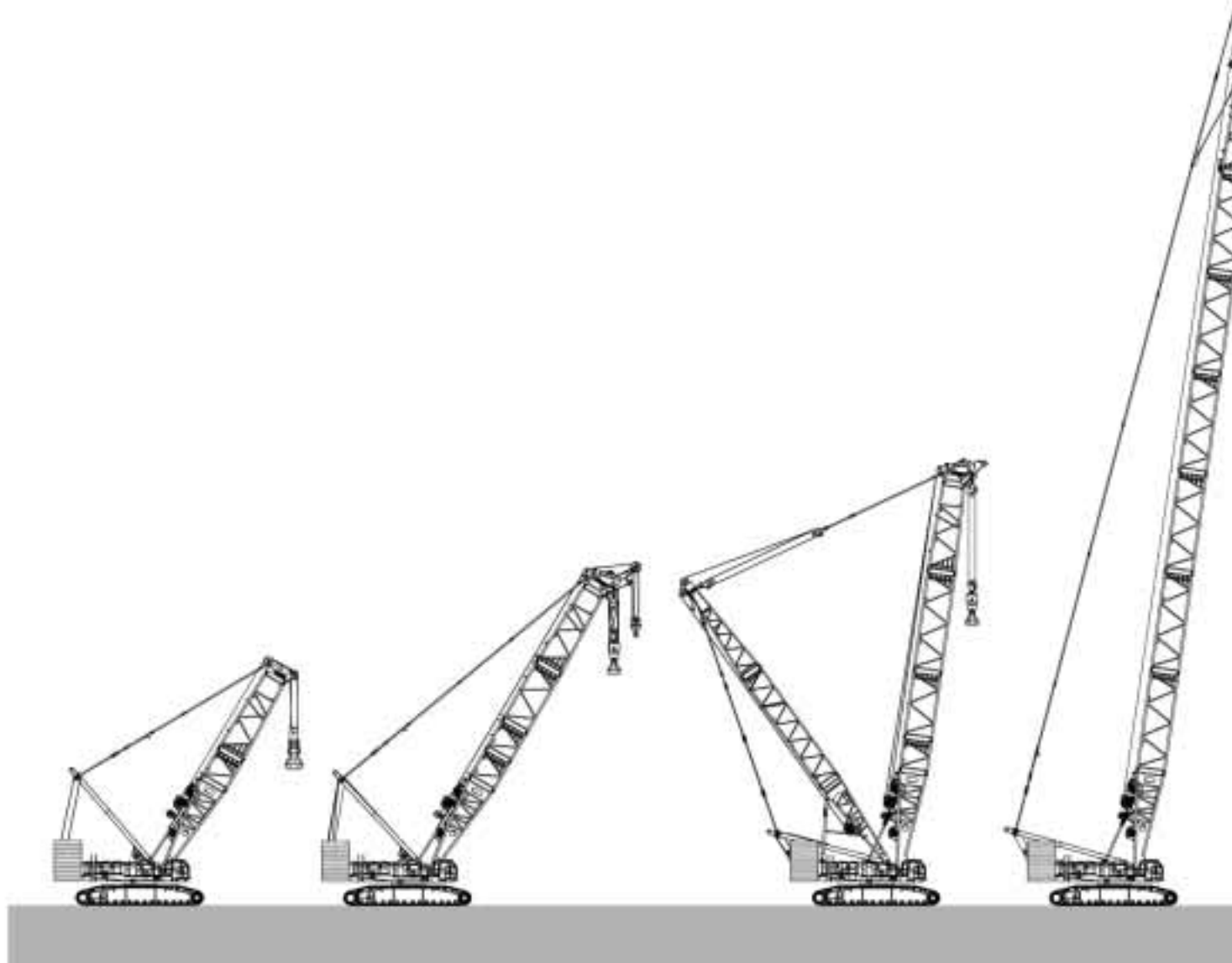

STD-ヘビーデューティ  
主boom

最大つり上げ能力：500t×6.2m  
boom長さ：21~42m

STD-ラフティング  
主boom

最大つり上げ能力：300t×9.3m  
boom長さ：30~84m

HL-ラフティング  
主boom

最大つり上げ能力：300t×9.3m  
boom長さ：36~84m

STD-ロング主boom

最大つり上げ能力：98t×15.0m  
boom長さ：90~108m

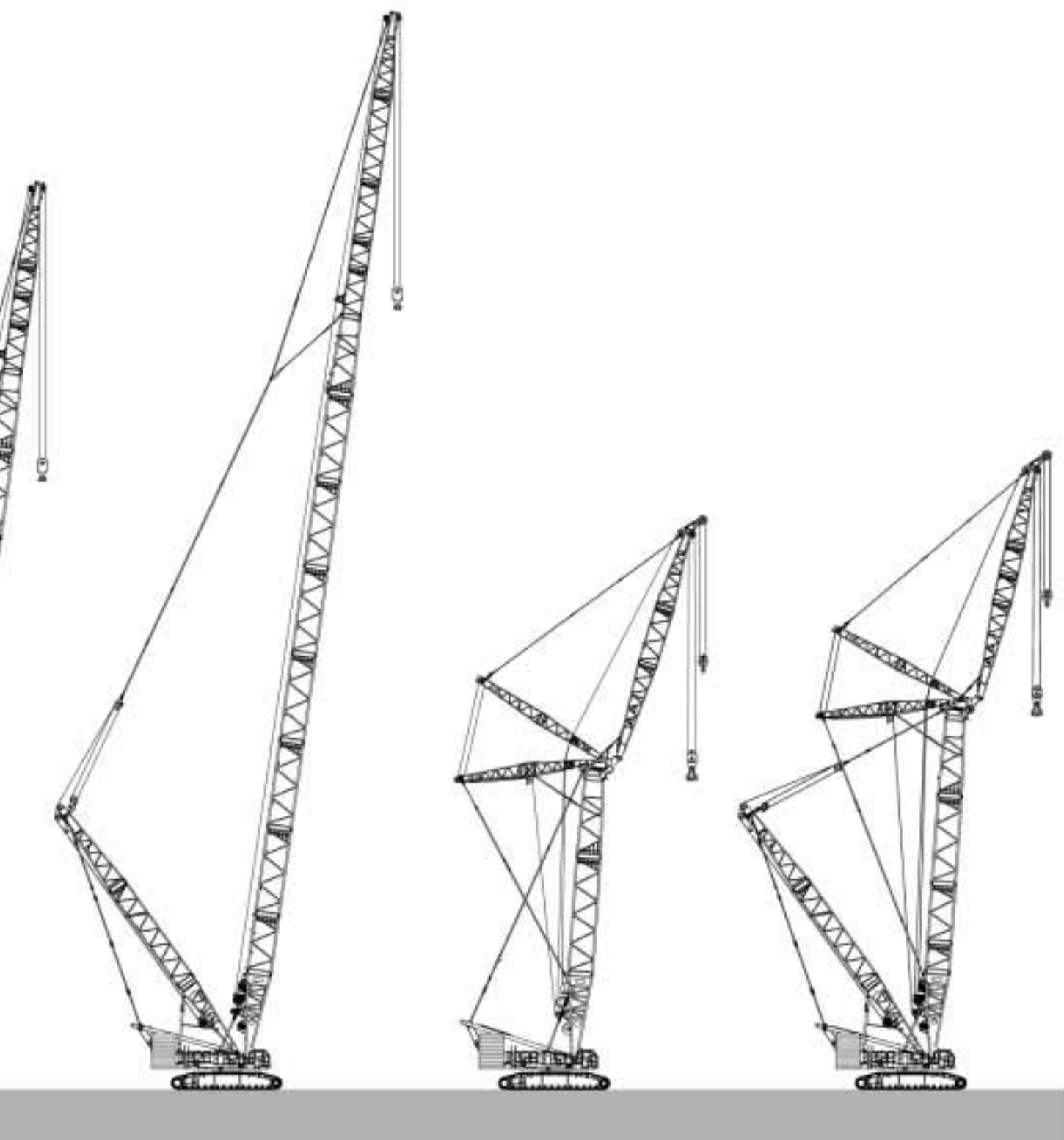

HL-ロング主ブーム

最大つり上げ能力：98t×15.8m  
ブーム長さ：90～108m

STD-ラフティングジブ

最大つり上げ能力：184t×14.0m  
最大ブーム+ジブ長さ：66+72m

注) 12m中間マストと自立用の  
20tカウンタウエイトが必要です。

HL-ラフティングジブ

最大つり上げ能力：200t×14.4m  
最大ブーム+ジブ長さ：66+72m

## ▶主要諸元 (型式 : SL6000J)

項目		仕様	STANDARD (STD)	HEAVY LIFT (HL)
ヘビーデューティ主ブーム	最大つり上げ能力	t×m	500×6.2	367.5×8.3
	ブーム長さ	m	21~42	36~42
ラフティング主ブーム	最大つり上げ能力	t×m	300×9.3	300×9.3
	ブーム長さ	m	30~84	36~84
ロング主ブーム	ブーム長さ	m	90~108	
ラフティングジブ	最大つり上げ能力	t×m	184×14.0	200×14.4
	最大ブーム+ジブ長さ	m	66+72 <sup>1</sup>	66+72
	ラフティングブーム角度		66°~86°	
能力増大装置 (HLマスト) 長さ		m	-	30
ロープ速度	巻上1	m/min	*110~3	
	巻上2	m/min	*110~3	
	起伏1	m/min	*(20~2)×2	
	起伏2	m/min	*30~2	
	起伏3	m/min	*30~2	
旋回速度		min <sup>-1</sup> {rpm}	0.9{0.9}	
走行速度		km/h	*1.0/0.6	
作業時質量 (基本姿勢)		t	424	461
接地圧 (基本姿勢)		kPa{kgf/cm <sup>2</sup> }	136{1.4}	148{1.5}
登坂能力 (tan )		%(度)	20%(11.3)	
定格ラインプル		kN{tf}	137{14.0}	
エンジン	名称		日野E13C	
	定格出力	kW/min <sup>-1</sup>	320/2,000	
ワイヤロープ	巻上1	mm	28	
	巻上2	mm	28	
	起伏1	mm	28	
	起伏2	mm	28	
	起伏3	mm	28	

各ロープ速度はドラム1層目での値です。

\*印の速度は軽負荷の時の値であり、負荷により速度の変動があります。

<sup>1</sup>印のラフティングブーム+ジブ長さには、12m中間HLマストと自立用の20tカウンタウエイトが必要です。

単位は国際単位系のSI単位で、{ }内は従来表示です。

▶全体図(単位: mm)

縮尺: 約 1/300

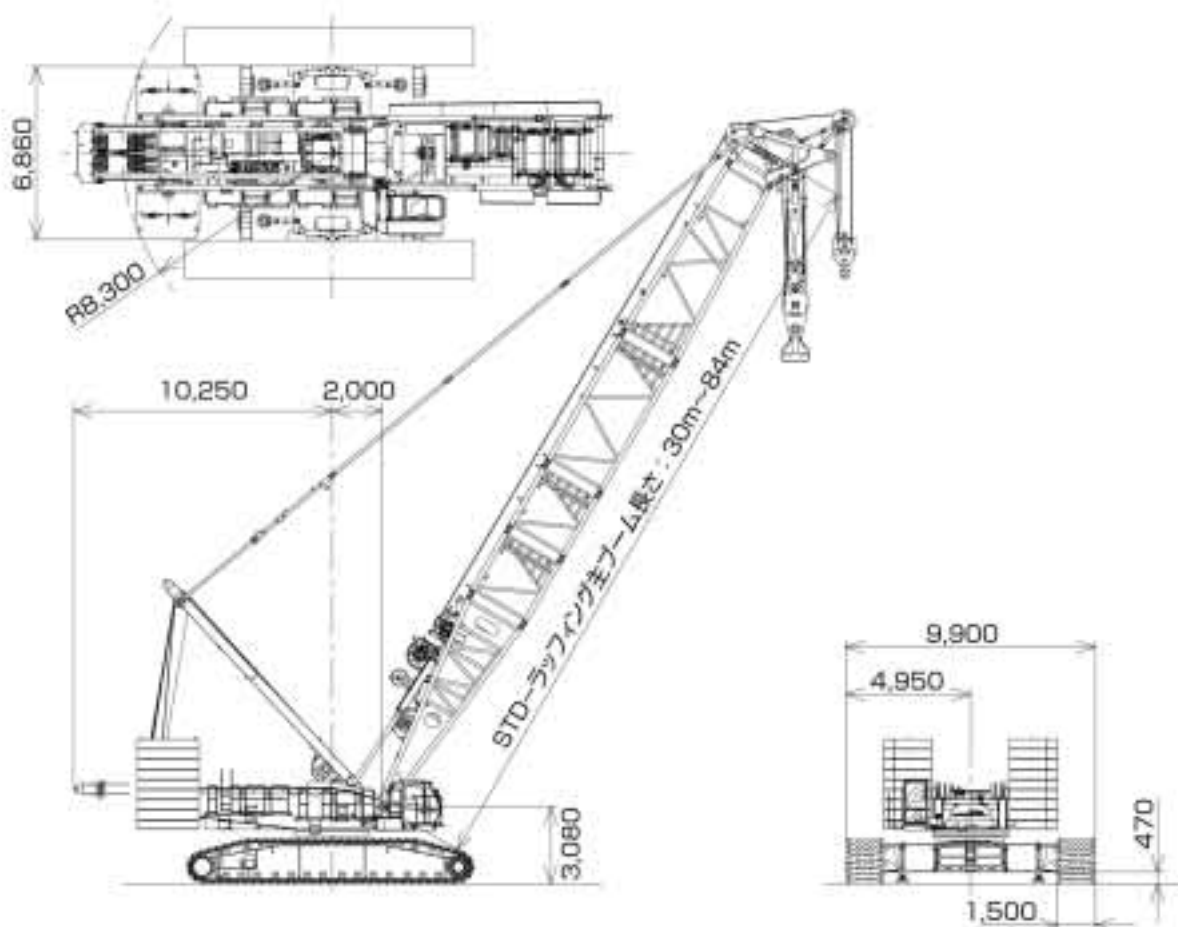

▶能力増大装置付仕様

縮尺: 約 1/650

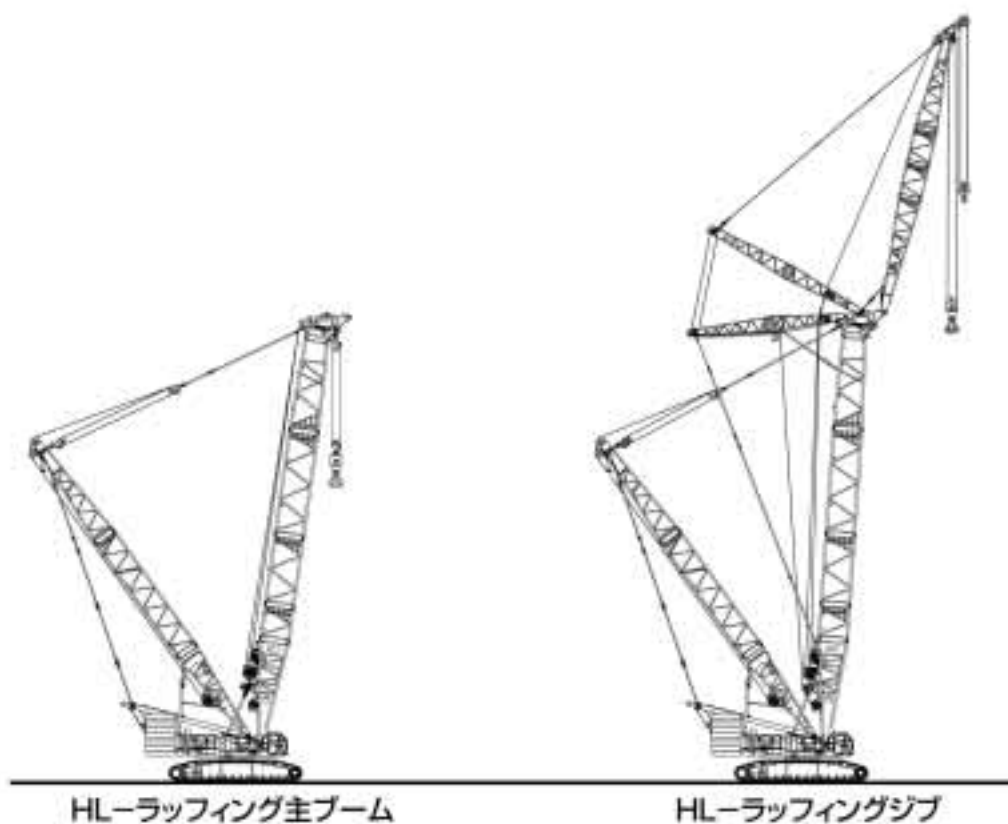

## ■仕様とアタッチメント（アタッチメントの互換性）

仕様	STANDARD( STD )						HEAVY LIFT( HL )			
	クレーン			ラフティングジブ			クレーン			ラフティングジブ
	ヘビー デューティ 主ブーム	ラフティング 主ブーム	ロング 主ブーム				ヘビー デューティ 主ブーム	ラフティング 主ブーム	ロング 主ブーム	
最長ブーム(+ジブ)長さ	42m	84m	108m	60m+54m	66m+72m	42m	84m	108m	66m+72m	
カウンタ ウエイト	カウンタウエイト(上部本体)	180 t				200 t	180 t			
	カーボディウエイト	50 t				50 t	50 t			
ブーム	9m下部ブーム	共用(1)	共用(1)	共用(1)	共用(1)	共用(1)	共用(1)	共用(1)	共用(1)	共用(1)
	1m上部ブーム(ヘビーデューティ)	ヘビー専用(1)	-	-	-	-	ヘビー専用(1)	-	-	-
	1m上部ブーム(ラフティング)	-	共用(1)	-	共用(1)	共用(1)	-	共用(1)	-	共用(1)
	3m中間ブーム	共用(2)	共用(2)	-	共用(2)	共用(1)	共用(2)	共用(2)	-	共用(2)
	6m中間ブーム	共用	共用(1)	共用(1)	共用	共用(1)	共用	共用(1)	共用(1)	共用(1)
	9m中間ブーム	共用(2)	共用(6)	共用(6)	共用(4)	共用(3)	共用(2)	共用(6)	共用(6)	共用(4)
	8m中間テーパーブーム	共用(1)	共用(1)	共用(1)	共用(1)	共用(1)	共用(1)	共用(1)	共用(1)	共用(1)
ラフティング ジブ	10m下部ラフティングジブ	-	-	-	ジブ専用(1)	ジブ専用(1)	-	-	-	ジブ専用(1)
	8m上部ラフティングジブ	-	-	共用(1)*1	共用(1)	共用(1)	-	-	共用(1)*1	共用(1)
	3m中間ラフティングジブ	-	-	共用(1)*2	共用(1)	共用(1)	-	-	共用(1)*2	共用(1)
	6m中間ラフティングジブ	-	-	共用(1)*2	共用(1)	共用(1)	-	-	共用(1)*2	共用(1)
	9m中間ラフティングジブ	-	-	共用(1)*2	共用(3)	共用(5)	-	-	共用(1)*2	共用(5)
	5mロング中継ブーム	-	-	ロング専用(1)	-	-	-	-	ロング専用(1)	-
HLマスト	9m下部HLマスト	-	-	-	-	-	共用(1)			
	9m上部HLマスト	-	-	-	-	-	共用(1)			
	12m中間HLマスト	-	-	-	-	共用(1)*3	共用(1)			

- のブームは共用ではありません。

( )内の数字は、各最長長さ時の使用本数を示します。

\*1 ロングブーム仕様では上部ブームとして使用します。

\*2 ロングブーム仕様では中間ブームとして使用します。

\*3 STD - ラフティングジブ仕様の66mブームの構成では中間ブームとして使用します。

## ■フック巻上限界（単位：m）

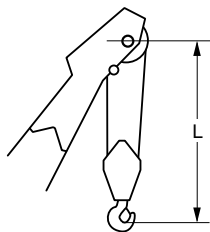

使用フック	L		
	ヘビーデューティ/ ラフティング主ブーム	ロング主ブーム	ラフティングジブ
500tフック	7.9	-	-
300tフック	7.3	-	-
200tフック(つり下げシーブ付きの場合)	7.3	-	8.7
200tフック(つり下げシーブ無しの場合)	5.0	-	6.5
120tフック	4.5	7.3	6.0
70tフック	4.5	7.3	6.0
40tフック	4.2	7.0	5.7
14tボールフック	6.3	5.3	5.7

## ▶ 定格総荷重

- 定格総荷重とは、水平堅土上における転倒荷重の78%以内で、フックブロック、玉掛用ワイヤロープ等のつり具の質量を含んだ値です。
- 作業半径とはクレーン旋回中心よりつり上荷重の重心までの水平距離を意味します。
- 実際につり上げ得る荷重は定格総荷重から（フック + 玉掛用ワイヤロープ等のつり具）の質量を差し引いた値になります。
- 定格総荷重をつる場合にも風の影響、地盤の状態、作業速度その他安全作業に有害な状況がある時はオペレータは荷重の軽減、作業速度を遅くするなど状況に応じた判断をする責任があります。
- 表中の空欄の個所では作業を行うことができません。
- すべてのブーム長さにおける中間ブームの構成は取扱説明書の指示を厳守してください。
- 主ブームに補助シーブを取り付けたままで主フックを使用する場合の定格総荷重は、主ブーム定格総荷重から、一律0.7t差し引いた値となります。ただし最小定格総荷重はラフティング主ブームは7.7t、ロング主ブームは6.2tとします。
- 補助シーブを装着できる主ブーム長さは下記のとおりです。
  - [ STANDARD ]
    - ラフティング主ブーム：30.0m～84.0m
    - ロング主ブーム：90.0m～102.0m
  - [ HEAVY LIFT ]
    - ラフティング主ブーム：36.0m～84.0m
    - ロング主ブーム：90.0m～108.0m
- ラフティングジブが装着された状態では、主ブームづりはできません。
- 下記の仕様では、必ず自立用のカウンタウエイト（20t）を使用してください。
  - [ STANDARD ] 66.0mラフティングブームにラフティングジブを装着した場合。

### ● 巻上げロープ巻掛本数に対する最大巻上荷重とフックの質量

フック 呼称	最大巻上荷重(t)																				フック 質量	
	1本掛	2本掛	3本掛	4本掛	5本掛	6本掛	7本掛	8本掛	9本掛	10本掛	11本掛	12本掛	13本掛	14本掛	15本掛	16本掛	20本掛	24本掛	28本掛	36本掛		44本掛
500t	-	-	-	-	-	-	-	112	-	-	-	164	-	-	-	220	280	336	370	450	500	11.7t
300t	-	-	-	-	-	-	-	112	-	-	-	164	-	-	-	220	280	300	-	-	-	7.8t
200t	-	28	42	56	70	84	98	112	126	140	152	164	174	184	192	200	-	-	-	-	-	7.1t
120t	-	28	42	56	70	84	98	112	120	-	-	-	-	-	-	-	-	-	-	-	-	4.5t
70t	-	28	42	56	70	-	-	-	-	-	-	-	-	-	-	-	-	-	-	-	-	3.1t
40t	-	28	40	-	-	-	-	-	-	-	-	-	-	-	-	-	-	-	-	-	-	2.0t
14t ボールフック	14	-	-	-	-	-	-	-	-	-	-	-	-	-	-	-	-	-	-	-	-	0.8t

500t、300tフックはダブルドラムの値です。

# STANDARD

## クローラクレーン作動範囲図

### ヘビーデューティ主ブーム

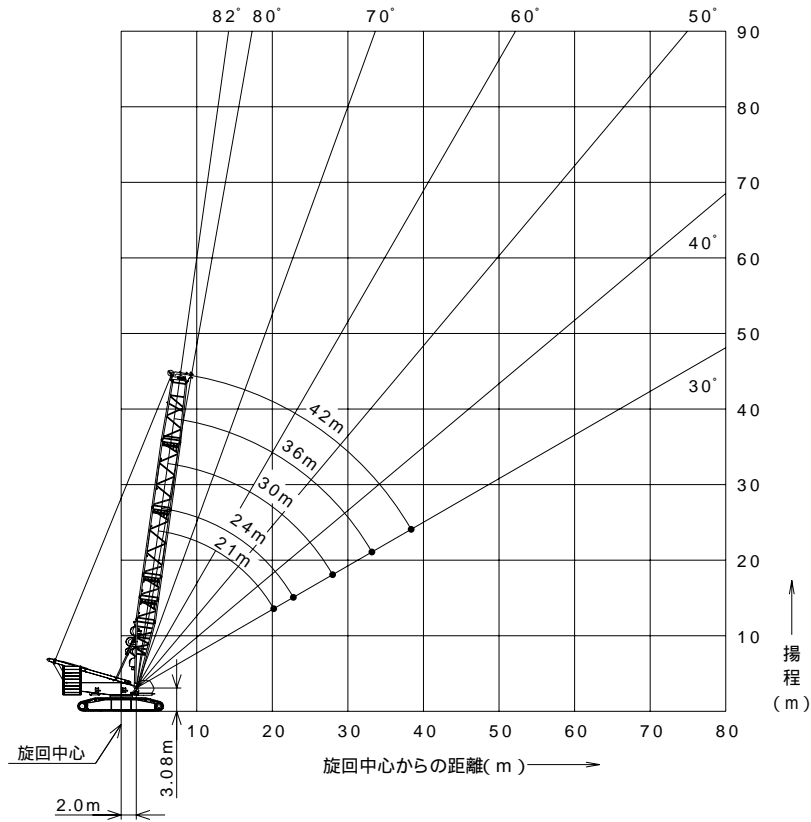

### ラフニング主ブーム

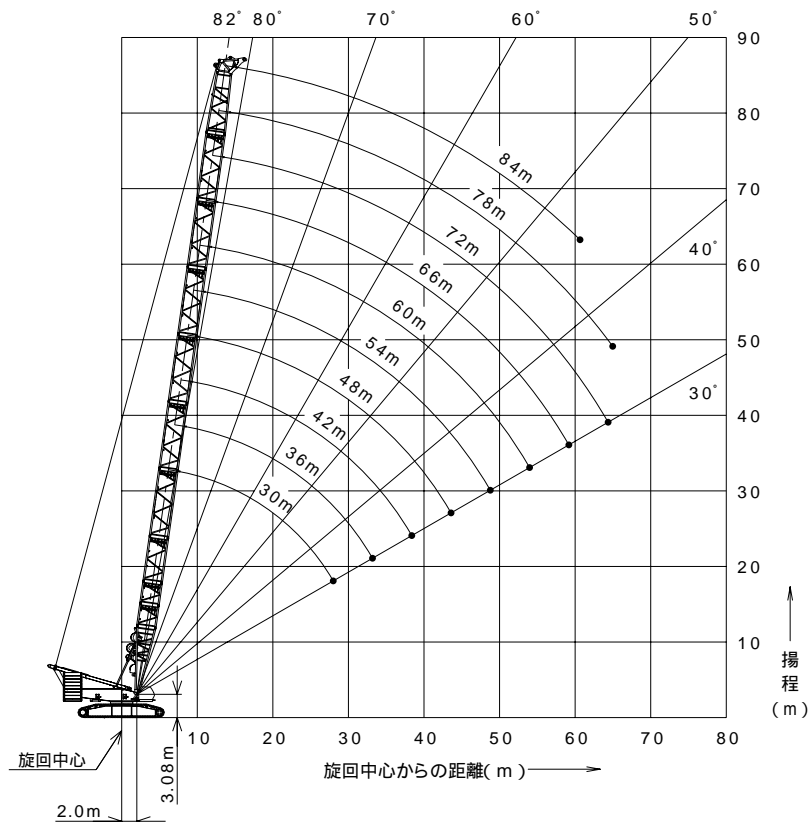



# STANDARD

## ▶ロング主ブーム

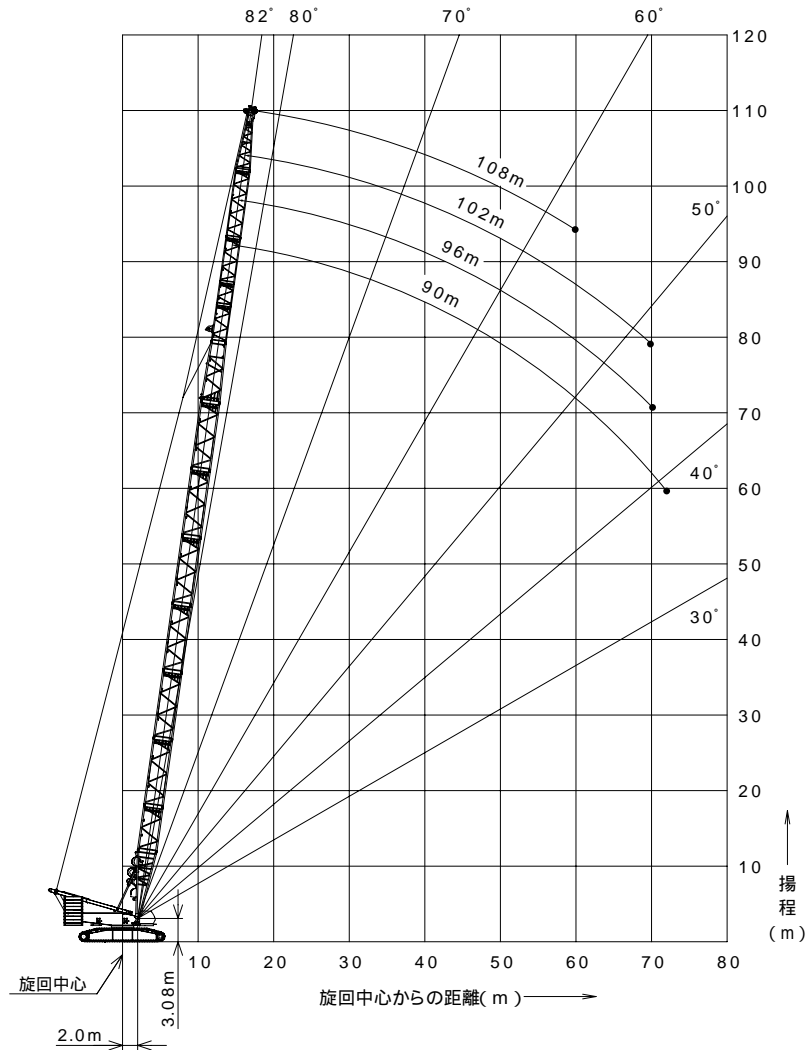

## ▶ヘビーデューティ主ブーム定格総荷重表

(単位:t)

ブーム長さ 作業半径(m)	21.0	24.0	30.0	36.0	42.0	ブーム長さ 作業半径(m)
6.0	500.0/6.2m	450.0/6.7m				6.0
7.0	428.6	425.0	390.0/7.5m			7.0
8.0	375.0	375.0	365.0	340.0/8.3m		8.0
9.0	333.3	330.0	325.0	322.0	311.7/9.2m	9.0
10.0	296.5	294.0	292.0	290.0	280.1	10.0
12.0	233.0	233.3	232.8	232.1	225.0	12.0
14.0	190.4	192.0	191.5	190.7	187.0	14.0
16.0	157.9	158.7	158.8	158.9	158.6	16.0
18.0	132.6	133.3	133.3	133.4	133.1	18.0
20.0	113.8	114.4	114.4	114.3	114.0	20.0
22.0		97.4	97.3	97.2	97.1	22.0
24.0			87.0	86.9	86.4	24.0
26.0			78.5	78.3	77.8	26.0
28.0			70.7	70.4	69.8	28.0
30.0			68.5/28.6m	63.7	63.1	30.0
34.0				53.5/33.8m	52.4	34.0
38.0					44.4	38.0
42.0					42.6/39.0m	42.0
ロープ掛数	44	36	36	28	24	ロープ掛数

ダブルドラムを使用する必要があります。

# STANDARD

## ▶ラフティング主ブーム定格総荷重表

(単位:t)

ブーム長さ 作業半径(m)	30.0	36.0	42.0	48.0	54.0	60.0	66.0	72.0	78.0	84.0	ブーム長さ 作業半径(m)
7.0	300.0/7.7m										7.0
8.0	300.0	300.0/8.5m									8.0
9.0	300.0	300.0	300.0/9.3m								9.0
10.0	292.1	291.4	278.2	258.6/10.2m	224.6/11.0m	197.3/11.8m					10.0
12.0	230.2	229.5	222.9	212.7	203.2	194.3	175.1/12.7m	156.1/13.5m			12.0
14.0	188.9	188.2	184.8	177.0	169.8	163.0	156.5	149.9	140.3/14.3m	126.4/15.2m	14.0
16.0	157.8	157.6	156.9	150.7	145.0	139.4	134.1	128.6	123.8	119.0	16.0
18.0	132.4	132.1	131.4	130.5	125.7	121.0	116.5	111.9	107.8	103.6	18.0
20.0	113.4	113.0	112.3	111.8	110.3	106.2	102.4	98.3	94.7	91.1	20.0
22.0	98.6	98.3	97.5	96.9	96.4	94.2	90.7	87.0	83.9	80.6	22.0
24.0	86.9	86.5	85.7	85.1	84.6	83.9	81.0	77.6	74.8	71.8	24.0
26.0	77.3	76.9	76.1	75.5	74.9	74.2	72.7	69.6	67.0	64.2	26.0
28.0	69.4	68.9	68.1	67.4	66.8	66.1	65.4	62.7	60.3	57.7	28.0
30.0	66.8/28.7m	62.2	61.4	60.7	60.1	59.3	58.6	56.7	54.4	52.0	30.0
34.0		51.7/33.9m	50.7	49.9	49.3	48.4	47.7	46.7	44.7	42.4	34.0
38.0			42.6	41.8	41.0	40.2	39.4	38.4	37.0	34.9	38.0
42.0			40.7/39.1m	35.4	34.6	33.7	32.7	31.4	30.4	28.7	42.0
46.0				32.3/44.3m	29.5	28.3	27.2	25.9	24.8	23.6	46.0
50.0					25.7/49.5m	23.8	22.6	21.3	20.2	19.0	50.0
54.0						20.6	18.9	17.5	16.4	15.1	54.0
58.0						19.6/54.7m	15.7	14.3	13.1	11.9	58.0
62.0							14.4/59.9m	11.6	10.3	8.8	62.0
66.0								9.7/65.1m	7.6		66.0
ロープ掛数	24	24	24	20	20	16	16	12	12	12	ロープ掛数

表中の太線で囲まれた荷重はダブルドラムを使用する必要があります。

## ▶ラフティングブーム補助シーブ定格総荷重表(主ブームにフックなし)

(単位:t)

ブーム長さ 作業半径(m)	30.0	36.0	42.0	48.0	54.0	60.0	66.0	72.0	78.0	84.0	ブーム長さ 作業半径(m)
8.0	28.0/8.8m										8.0
9.0	28.0	28.0/9.6m									9.0
10.0	28.0	28.0	28.0/10.4m	28.0/11.3m							10.0
12.0	28.0	28.0	28.0	28.0	28.0/12.1m	28.0/12.9m	28.0/13.8m				12.0
14.0	28.0	28.0	28.0	28.0	28.0	28.0	28.0	28.0/14.6m	28.0/15.4m		14.0
16.0	28.0	28.0	28.0	28.0	28.0	28.0	28.0	28.0	28.0	28.0/16.3m	16.0
18.0	28.0	28.0	28.0	28.0	28.0	28.0	28.0	28.0	28.0	28.0	18.0
20.0	28.0	28.0	28.0	28.0	28.0	28.0	28.0	28.0	28.0	28.0	20.0
22.0	28.0	28.0	28.0	28.0	28.0	28.0	28.0	28.0	28.0	28.0	22.0
24.0	28.0	28.0	28.0	28.0	28.0	28.0	28.0	28.0	28.0	28.0	24.0
26.0	28.0	28.0	28.0	28.0	28.0	28.0	28.0	28.0	28.0	28.0	26.0
28.0	28.0	28.0	28.0	28.0	28.0	28.0	28.0	28.0	28.0	28.0	28.0
30.0	28.0/28.7m	28.0	28.0	28.0	28.0	28.0	28.0	28.0	28.0	28.0	30.0
34.0		28.0/33.9m	28.0	28.0	28.0	28.0	28.0	28.0	28.0	28.0	34.0
38.0			28.0	28.0	28.0	28.0	28.0	28.0	28.0	28.0	38.0
42.0			28.0/39.1m	28.0	28.0	28.0	28.0	28.0	28.0	28.0	42.0
46.0				28.0/44.3m	28.0	27.6	26.5	25.2	24.1	22.9	46.0
50.0					25.0/49.5m	23.1	21.9	20.6	19.5	18.3	50.0
54.0						19.9	18.2	16.8	15.7	14.4	54.0
58.0						18.9/54.7m	15.0	13.6	12.4	11.2	58.0
62.0							13.7/59.9m	10.9	9.6	8.1	62.0
66.0								9.0/65.1m			66.0
ロープ掛数	2	2	2	2	2	2	2	2	2	2	ロープ掛数

# STANDARD

## ▶ロング主ブーム定格総荷重表

(単位:t)

ブーム長さ 作業半径(m)	90.0	96.0	102.0	108.0	ブーム長さ 作業半径(m)
14.0	98.0/15.0m	84.0/15.8m			14.0
16.0	96.0	83.7	70.0/16.6m	60.0/17.5m	16.0
18.0	93.0	81.1	68.5	58.8	18.0
20.0	90.0	78.5	66.3	55.1	20.0
22.0	81.1	76.0	64.2	51.4	22.0
24.0	72.6	70.8	62.1	48.4	24.0
26.0	64.9	64.2	60.0	45.4	26.0
28.0	58.4	58.3	57.3	42.9	28.0
30.0	52.9	52.8	51.3	40.4	30.0
34.0	44.1	43.3	42.1	36.7	34.0
38.0	37.0	35.8	35.1	33.2	38.0
42.0	31.0	30.2	29.7	28.6	42.0
46.0	26.0	25.4	24.9	22.6	46.0
50.0	21.8	21.3	20.8	17.3	50.0
54.0	18.1	17.6	17.1	12.7	54.0
58.0	14.8	14.4	14.0	8.7	58.0
62.0	12.0	11.6	11.1	6.8/60.0m	62.0
66.0	9.5	9.0	8.5		66.0
70.0	7.2	6.7	6.2		70.0
72.0	6.2				72.0
ロープ掛数	7	6	5	5	ロープ掛数

## ▶ロング補助シーブ定格総荷重表 (主ブームにフックなし)

(単位:t)

ブーム長さ 作業半径(m)	90.0	96.0	102.0	ブーム長さ 作業半径(m)
14.0	28.0/15.9m			14.0
16.0	28.0	28.0/16.7m	28.0/17.5m	16.0
18.0	28.0	28.0	28.0	18.0
20.0	28.0	28.0	28.0	20.0
22.0	28.0	28.0	28.0	22.0
24.0	28.0	28.0	28.0	24.0
26.0	28.0	28.0	28.0	26.0
28.0	28.0	28.0	28.0	28.0
30.0	28.0	28.0	28.0	30.0
34.0	28.0	28.0	28.0	34.0
38.0	28.0	28.0	28.0	38.0
42.0	28.0	28.0	28.0	42.0
46.0	25.3	24.7	24.2	46.0
50.0	21.1	20.6	20.1	50.0
54.0	17.4	16.9	16.4	54.0
58.0	14.1	13.7	13.3	58.0
62.0	11.3	10.9	10.4	62.0
66.0	8.8	8.3	7.8	66.0
70.0	6.5			70.0
ロープ掛数	2	2	2	ロープ掛数

# STANDARD

## ▶ラッピングジブ作動範囲図

### ■ラッピングジブ (ブーム角度86°)

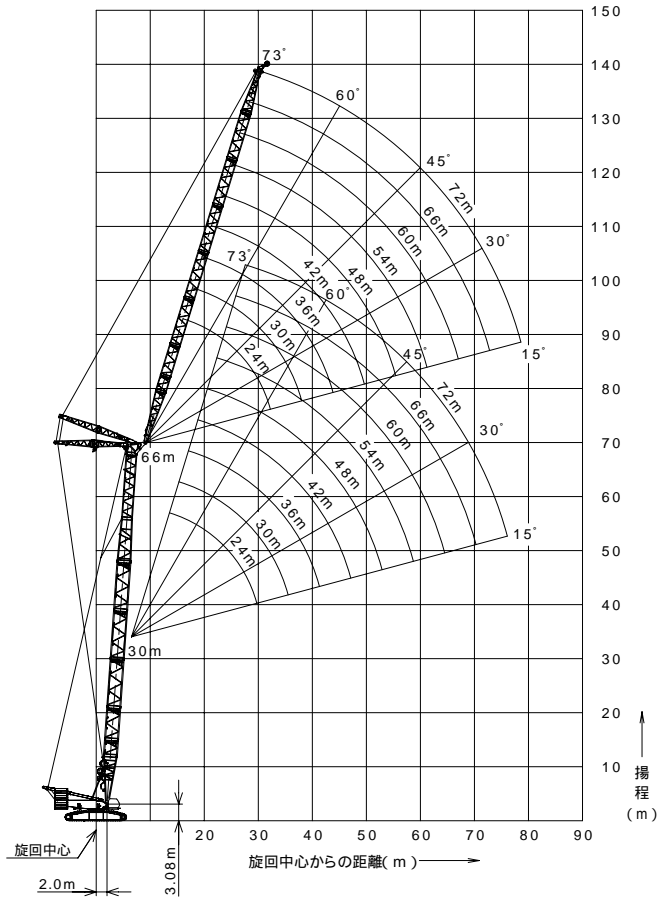

### ■ラッピングジブ (ブーム角度76°)

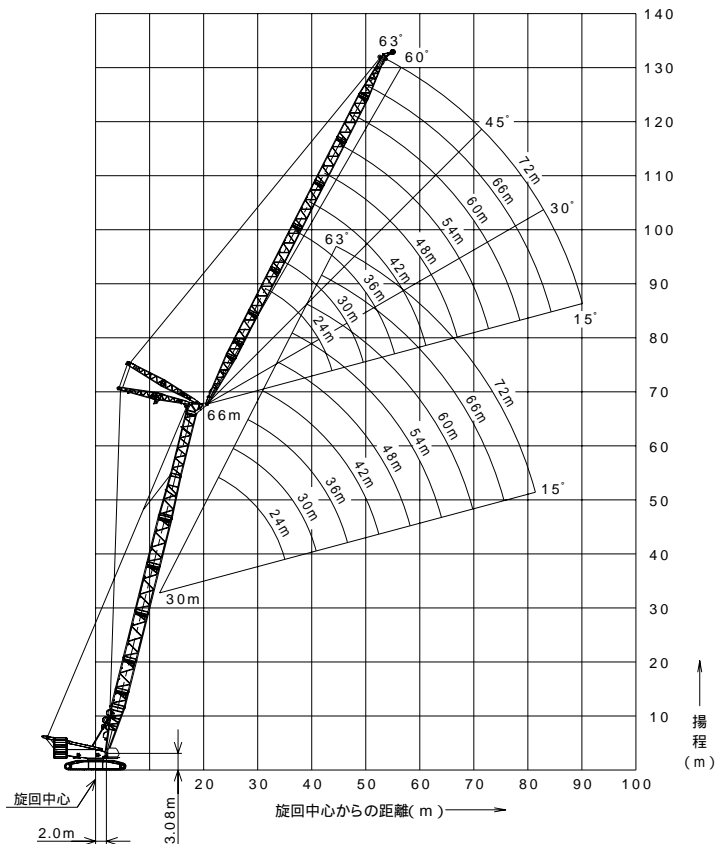

# STANDARD

## ▶ラフニングジブ定格総荷重表

(単位:t)

ブーム長さ(m)		30.0															ブーム長さ(m)	
ジブ長さ(m)		24.0			42.0			54.0			66.0			72.0			ジブ長さ(m)	
ブーム角度		86°	76°	66°	86°	76°	66°	86°	76°	66°	86°	76°	66°	86°	76°	66°	ブーム角度	
作業半径(m)	14.0	184.0															14.0	
	15.0	173.5															15.0	
	16.0	160.5															16.0	
	17.0	151.0															17.0	
	18.0	141.6															18.0	
	20.0	125.3				111.6											20.0	
	22.0	112.2				107.1											22.0	
	24.0	100.1	93.7			97.9			85.2								24.0	
	26.0	89.8	84.2			89.3			85.2								26.0	
	28.0	81.3	76.2			80.9			78.9			67.3					28.0	
	30.0		69.5			73.8			73.1			67.3			60.2		30.0	
	34.0		58.8	54.9		62.5	57.7		61.9			60.4			58.7		34.0	
	38.0			47.3		54.0	49.7		53.3	48.8		52.2			51.8		38.0	
	42.0					47.2	43.5		46.6	42.6		45.5			45.1		42.0	
	46.0					41.8	38.4	35.1	41.2	37.5		40.1	36.2		39.4	35.0	46.0	
	50.0						34.3	31.3	36.7	33.4	30.2	34.6	31.9		33.0	30.7	50.0	
	54.0							28.1	32.7	29.9	27.0	29.5	28.3		27.8	27.1	54.0	
	58.0								28.5	27.0	24.2	25.2	25.2	21.9	23.5	24.1	58.0	
	62.0									24.5	21.9	21.6	22.6	19.5	19.8	21.5	18.3	62.0
	66.0										19.9	18.6	20.5	17.5	16.7	19.3	16.3	66.0
70.0											16.1	18.6	15.8	14.1	17.4	14.5	70.0	
74.0												17.1	14.3	11.9	15.8	13.0	74.0	
78.0													13.0		14.4	11.7	78.0	
82.0																10.6	82.0	
86.0																9.8	86.0	
ロープ掛数		16			8			7			5			5			ロープ掛数	

表中の太線で囲まれた荷重はダブルドラムを使用する必要があります。

(単位:t)

ブーム長さ(m)		36.0															ブーム長さ(m)
ジブ長さ(m)		24.0			42.0			54.0			66.0			72.0			ジブ長さ(m)
ブーム角度		86°	76°	66°	86°	76°	66°	86°	76°	66°	86°	76°	66°	86°	76°	66°	ブーム角度
作業半径(m)	15.0	167.8															15.0
	16.0	157.0															16.0
	17.0	148.2															17.0
	18.0	139.4															18.0
	20.0	124.3				111.0											20.0
	22.0	111.3				103.7											22.0
	24.0	99.8				95.0			84.7								24.0
	26.0	89.6	82.5			87.6			82.7								26.0
	28.0	81.1	74.7			80.7			76.6			66.8					28.0
	30.0	73.8	68.1			73.6			71.3			66.8			59.7		30.0
	34.0		57.6			62.4	56.4		61.5			58.7			57.0		34.0
	38.0				45.4	53.8	48.6		53.0			51.9			50.3		38.0
	42.0				39.6	47.1	42.5		46.3	41.4		45.2			44.9		42.0
	46.0					41.7	37.5	33.5	40.9	36.4		39.8	34.8		39.2		46.0
	50.0						33.4	29.8	36.5	32.4		34.4	30.5		32.8	29.4	50.0
	54.0							26.7	32.4	29.0	25.1	29.2	27.0		27.5	25.8	54.0
	58.0							24.0	28.1	26.1	22.4	24.9	24.0		23.1	22.9	58.0
	62.0								23.7	20.1	21.2	21.5	17.7	19.4	20.3		62.0
	66.0									18.1	18.1	19.4	15.8	16.3	18.2	14.5	66.0
	70.0									16.3	15.5	17.5	14.1	13.6	16.3	12.8	70.0
74.0											16.0	12.7	11.3	14.7	11.4	74.0	
78.0												11.3		13.4	10.1	78.0	
82.0													10.1		11.4	9.1	82.0
86.0																8.2	86.0
ロープ掛数		16			8			7			5			5			ロープ掛数

表中の太線で囲まれた荷重はダブルドラムを使用する必要があります。

# STANDARD

(単位:t)

ブーム長さ(m)		42.0															ブーム長さ(m)
ジブ長さ(m)		24.0			42.0			54.0			66.0			72.0			ジブ長さ(m)
ブーム角度		86°	76°	66°	86°	76°	66°	86°	76°	66°	86°	76°	66°	86°	76°	66°	ブーム角度
作業半径(m)	15.0	156.2/15.4m															15.0
	16.0	151.0															16.0
	17.0	142.7															17.0
	18.0	134.4															18.0
	20.0	121.0															20.0
	22.0	110.0			96.6												22.0
	24.0	99.3			92.1			84.1									24.0
	26.0	89.1			85.0			80.2									26.0
	28.0	80.6	72.9		78.8			74.4			66.3						28.0
	30.0	73.4	66.4		73.4			69.2			65.1			59.2			30.0
	34.0		56.2		62.2			60.7			57.0			55.3			34.0
	38.0		48.3	43.1	53.7	47.4		52.7			50.4			48.9			38.0
	42.0			37.6	47.0	41.4		46.0	40.1		44.9			43.5			42.0
	46.0				41.6	36.5		40.6	35.2		39.5	33.2		38.7			46.0
	50.0					32.5	27.8	36.2	31.3		34.0	29.1		32.4	27.9		50.0
	54.0					29.2	24.8	32.0	27.9		28.8	25.6		27.1	24.5		54.0
	58.0						22.2	27.7	25.0	20.1	24.4	22.7		22.7	21.6		58.0
	62.0						19.9		22.6	17.9	20.8	20.3	15.8	19.0	19.1		62.0
	66.0								20.6	16.0	17.6	18.2	13.9	15.8	17.0	12.6	66.0
	70.0									14.3	15.0	16.4	12.3	13.1	15.1	11.0	70.0
74.0									12.9		14.9	10.8	10.8	13.6	9.6	74.0	
78.0											13.6	9.5		12.3	8.4	78.0	
82.0												8.4		11.2	7.4	82.0	
86.0															6.6	86.0	
90.0															5.7	90.0	
ロープ掛数	12			7			7			5			5			ロープ掛数	

表中の太線で囲まれた荷重はダブルドラムを使用する必要があります。

(単位:t)

ブーム長さ(m)		48.0															ブーム長さ(m)
ジブ長さ(m)		24.0			42.0			54.0			66.0			72.0			ジブ長さ(m)
ブーム角度		86°	76°	66°	86°	76°	66°	86°	76°	66°	86°	76°	66°	86°	76°	66°	ブーム角度
作業半径(m)	16.0	143.5/16.2m															16.0
	17.0	137.4															17.0
	18.0	129.6															18.0
	20.0	116.9															20.0
	22.0	106.4			96.0												22.0
	24.0	97.7			89.1			82.4									24.0
	26.0	88.8			82.3			77.6									26.0
	28.0	80.3	71.1		76.4			72.0			65.7						28.0
	30.0	73.2	64.8		71.2			67.1			63.0			58.6			30.0
	34.0		54.7		61.8			58.9			55.2			53.5			34.0
	38.0		47.1		53.3	45.9		51.9			48.8			47.3			38.0
	42.0			35.2	46.6	40.0		45.4	38.6		43.6			42.2			42.0
	46.0			30.9	41.2	35.3		40.2	33.9		39.2			37.9			46.0
	50.0					31.4	25.0	35.9	29.9		33.5	27.6		31.9	26.3		50.0
	54.0					28.1	22.2	31.4	26.5		28.3	24.2		26.6	23.0		54.0
	58.0						19.7	27.1	23.7	17.6	23.9	21.4		22.2	20.1		58.0
	62.0						17.6		21.2	15.6	20.2	19.0		18.4	17.8		62.0
	66.0								19.1	13.8	17.1	16.9	11.7	15.2	15.7		66.0
	70.0									12.2	14.4	15.2	10.1	12.5	13.9	9.1	70.0
	74.0									10.9		13.7	8.8	10.2	12.4	7.8	74.0
78.0											12.3	7.6		11.1	6.7	78.0	
82.0												6.5		10.1		82.0	
ロープ掛数	12			7			6			5			5			ロープ掛数	

表中の太線で囲まれた荷重はダブルドラムを使用する必要があります。

# STANDARD

(単位:t)

ブーム長さ(m)		54.0												ブーム長さ(m)	
ジブ長さ(m)		24.0			42.0			54.0			66.0		72.0		ジブ長さ(m)
ブーム角度		86°	76°	66°	86°	76°	66°	86°	76°	66°	86°	76°	86°	76°	ブーム角度
作業半径(m)	17.0	132.2													17.0
	18.0	124.8													18.0
	20.0	112.8													20.0
	22.0	102.8			93.7										22.0
	24.0	94.5			86.1										24.0
	26.0	87.3			79.6			74.0							26.0
	28.0	80.0			74.0			69.7			64.2				28.0
	30.0	72.8	63.0		69.0			65.0			60.9		58.1		30.0
	34.0		53.2		60.6			57.0			53.4		51.7		34.0
	38.0		45.7		52.9	43.8		50.6			47.2		45.8		38.0
	42.0			32.1	46.2	38.5		45.2			42.2		40.8		42.0
	46.0			28.1	40.9	33.8		39.9	31.9		37.9		36.6		46.0
	50.0					29.9		35.5	28.0		32.7	25.9	31.2		50.0
	54.0					26.7	19.5	30.7	24.8		27.6	22.7	25.9	21.5	54.0
	58.0					23.9	17.2	26.4	22.1		23.2	19.9	21.5	18.7	58.0
	62.0						15.2		19.7	13.1	19.6	17.6	17.8	16.4	62.0
	66.0						13.6		17.7	11.5	16.5	15.6	14.6	14.4	66.0
	70.0									10.0	13.8	13.9	11.9	12.7	70.0
	74.0									8.8		12.4	9.6	11.2	74.0
	78.0									7.7		11.0		9.9	78.0
82.0													8.9	82.0	
86.0													8.0	86.0	
ロープ掛数		12			7			6			5		5	ロープ掛数	

表中の太線で囲まれた荷重はダブルドラムを使用する必要があります。

(単位:t)

ブーム長さ(m)		60.0												ブーム長さ(m)	
ジブ長さ(m)		24.0			42.0			54.0			66.0		72.0		ジブ長さ(m)
ブーム角度		86°	76°	66°	86°	76°	66°	86°	76°	66°	86°	76°	86°	76°	ブーム角度
作業半径(m)	17.0	121.3/17.8m													17.0
	18.0	120.1													18.0
	20.0	108.7													20.0
	22.0	99.3			90.4										22.0
	24.0	91.3			83.2										24.0
	26.0	84.5			77.0			72.4							26.0
	28.0	78.6			71.5			67.3							28.0
	30.0	72.5			66.7			62.8			58.3				30.0
	34.0		51.3		58.7			55.2			51.5		47.7		34.0
	38.0		44.2		52.3			49.0			45.6		44.2		38.0
	42.0		38.4		45.8	36.1		43.9			40.7		39.4		42.0
	46.0			25.1	40.5	31.6		39.6	29.8		36.6		35.3		46.0
	50.0			22.0		27.9		34.8	26.4		31.7	23.8	30.1		50.0
	54.0					24.8		29.8	23.3		26.7	21.1	25.0	19.4	54.0
	58.0					22.2	14.4	25.6	20.7		22.4	18.4	20.7	17.0	58.0
	62.0						12.7		18.4	10.9	18.8	16.2	17.1	14.8	62.0
	66.0						11.1		16.4	9.4	15.8	14.3	14.0	13.0	66.0
	70.0								14.7	8.0	13.1	12.6	11.3	11.3	70.0
	74.0									6.9		11.2	9.0	9.9	74.0
	78.0											10.0	7.0	8.7	78.0
82.0											8.8		7.7	82.0	
86.0													6.8	86.0	
ロープ掛数		12			8			6			5		4	ロープ掛数	

表中の太線で囲まれた荷重はダブルドラムを使用する必要があります。

# STANDARD

(単位:t)

ブーム長さ(m)	66.0												ブーム長さ(m)
ジブ長さ(m)	24.0			42.0			54.0		66.0		72.0		ジブ長さ(m)
ブーム角度	86°	76°	66°	86°	76°	66°	86°	76°	86°	76°	86°	76°	ブーム角度
18.0	101.6/18.5m												18.0
20.0	95.7												20.0
22.0	88.9			75.3									22.0
24.0	83.3			75.3									24.0
26.0	78.7			73.0			57.7						26.0
28.0	71.8			68.2			57.7						28.0
30.0	64.6			64.0			57.7	42.6					30.0
34.0		48.9		52.1			50.0	42.6	32.3				34.0
38.0		43.1		43.1			40.6	37.8	32.3				38.0
42.0		37.5		36.0	34.0		33.3	30.2	28.6				42.0
46.0				30.3	30.5		27.5	27.6	24.1	22.5			46.0
50.0			20.3		27.0		22.8	24.8	19.3	17.5			50.0
54.0			17.8		23.9		18.8	22.1	15.3	19.5	13.4	17.9	54.0
58.0					21.3	12.8	15.5	19.6	11.9	17.1	10.0	15.4	58.0
62.0						11.1		17.4	9.1	15.0	7.2	13.3	62.0
66.0						9.7		15.4	6.7	13.3	4.7	11.6	66.0
70.0						8.4		13.8	4.6	11.6		10.1	70.0
74.0										10.3		8.8	74.0
78.0										9.1		7.8	78.0
82.0										7.2		6.5	82.0
ロープ掛数	8			6			5		4		3		ロープ掛数

上表では、必ず自立用の20tカウンタウエイトを使用してください。  
 表中の太線で囲まれた荷重はダブルドラムを使用する必要があります。



Handwriting practice lines consisting of 28 horizontal dashed lines.

# HEAVY LIFT

## ▶クローラクレーン作動範囲図

### ■ヘビーデューティ主ブーム

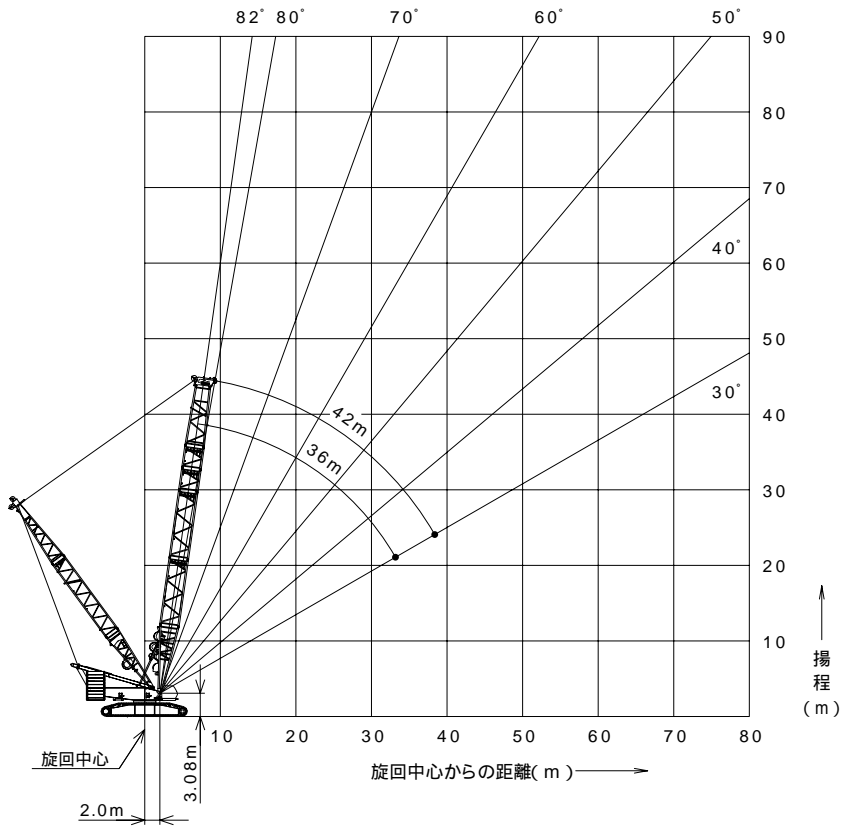

### ■ラフティング主ブーム

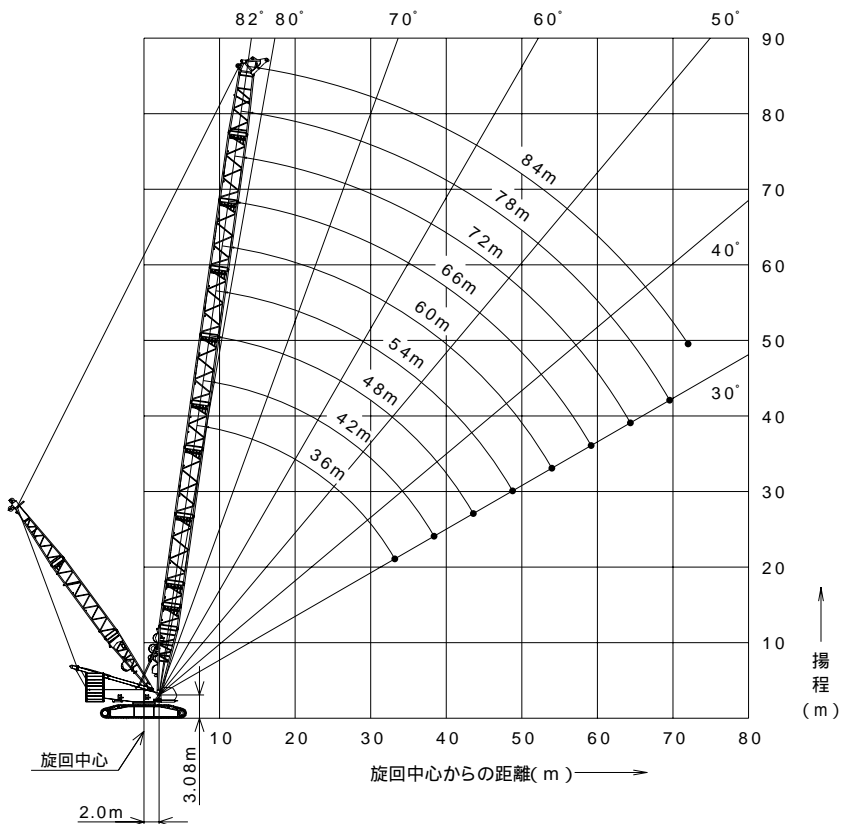

# HEAVY LIFT

## ▶ロング主ブーム

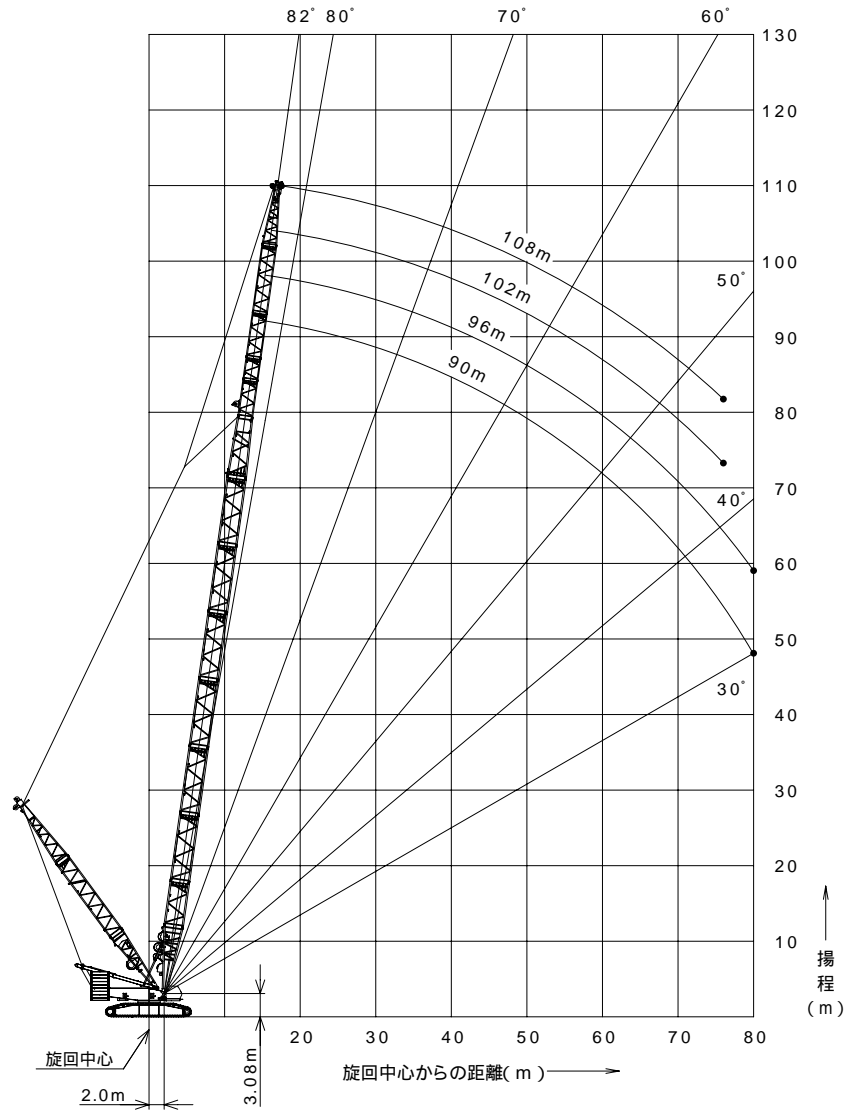

## ▶ヘビーデューティ主ブーム定格総荷重表

(単位:t)

ブーム長さ 作業半径(m)	36.0	42.0	ブーム長さ 作業半径(m)
8.0	367.5/8.3m		8.0
9.0	330.0	323.3/9.2m	9.0
10.0	286.4	286.9	10.0
12.0	225.4	225.9	12.0
14.0	184.9	185.2	14.0
16.0	156.0	156.1	16.0
18.0	134.4	134.3	18.0
20.0	117.7	117.4	20.0
22.0	104.1	103.9	22.0
24.0	93.2	92.8	24.0
26.0	84.0	83.6	26.0
28.0	76.2	75.9	28.0
30.0	69.5	69.1	30.0
32.0	63.5	63.3	32.0
34.0	58.7/33.8m	58.2	34.0
36.0		53.7	36.0
38.0		49.7	38.0
42.0		47.8/39.0m	42.0
ロープ掛数	28	24	ロープ掛数

ダブルドラムを使用する必要があります。

# HEAVY LIFT

## ▶ラフティング主ブーム定格総荷重表

(単位:t)

ブーム長さ (m) 作業半径(m)	36.0	42.0	48.0	54.0	60.0	66.0	72.0	78.0	84.0	ブーム長さ (m) 作業半径(m)
8.0	300.0/8.5m									8.0
9.0	300.0	300.0/9.3m								9.0
10.0	286.5	287.1	280.5/10.2m	252.1/11.0m	225.4/11.8m					10.0
12.0	224.9	225.3	225.0	224.6	221.9	199.7/12.7m	178.2/13.5m			12.0
14.0	184.0	184.2	183.8	183.3	183.0	178.8	171.2	160.6/14.3m	145.2/15.2m	14.0
16.0	154.8	154.9	154.6	153.9	153.4	152.7	147.4	142.2	137.0	16.0
18.0	132.9	132.9	132.6	132.0	131.4	129.7	128.5	124.1	119.7	18.0
20.0	116.0	115.9	115.5	114.8	114.3	113.5	112.6	109.5	105.6	20.0
22.0	102.4	102.2	101.9	101.2	100.6	99.8	98.9	97.3	93.8	22.0
24.0	91.3	91.1	90.7	90.1	89.6	88.6	87.7	87.1	84.0	24.0
26.0	82.0	81.8	81.4	80.8	80.3	79.3	78.3	77.6	75.5	26.0
28.0	74.2	74.0	73.5	72.9	72.4	71.5	70.4	69.7	68.2	28.0
30.0	67.5	67.2	66.8	66.1	65.7	64.8	63.8	63.0	61.8	30.0
32.0	61.6	61.4	60.9	60.3	59.8	58.9	58.0	57.1	56.1	32.0
34.0	56.6/33.9m	56.3	55.8	55.1	54.7	53.8	52.8	52.0	51.1	34.0
36.0		51.7	51.3	50.6	50.2	49.3	48.3	47.4	46.4	36.0
38.0		47.7	47.3	46.6	46.1	45.3	44.3	43.6	42.6	38.0
40.0		45.6/39.1m	43.6	43.0	42.5	41.7	40.7	40.0	39.0	40.0
42.0			40.4	39.7	39.3	38.4	37.5	36.7	35.6	42.0
44.0			37.4	36.8	36.3	35.5	34.5	33.7	32.7	44.0
46.0			37.0/44.3m	34.1	33.7	32.8	31.8	31.0	30.0	46.0
48.0				31.6	31.2	30.4	29.3	28.5	27.3	48.0
50.0				29.9/49.5m	29.0	28.1	27.1	26.1	24.9	50.0
52.0					26.9	26.0	25.0	23.9	22.6	52.0
54.0					25.0	24.1	23.0	21.8	20.6	54.0
56.0					24.3/54.7m	22.4	21.2	20.0	18.7	56.0
58.0						20.7	19.5	18.3	16.9	58.0
60.0						19.2/59.9m	18.0	16.7	15.3	60.0
62.0							16.6	15.3	13.9	62.0
64.0							15.4	14.0	12.5	64.0
66.0							14.8/65.1m	12.8	11.2	66.0
68.0								11.7	10.0	68.0
70.0								10.6	8.8	70.0
72.0								10.5/70.3m	7.7	72.0
ロープ掛数	24	24	24	20	20	16	16	12	12	ロープ掛数

表中の太線で囲まれた荷重はダブルドラムを使用する必要があります。

## ▶ラフティングブーム補助シーブ定格総荷重表 (主ブームにフックなし)

(単位:t)

ブーム長さ (m) 作業半径(m)	36.0	42.0	48.0	54.0	60.0	66.0	72.0	78.0	84.0	ブーム長さ (m) 作業半径(m)
9.0	28.0/9.6m									9.0
10.0	28.0	28.0/10.4m	28.0/11.3m							10.0
12.0	28.0	28.0	28.0	28.0/12.1m	28.0/12.9m	28.0/13.8m				12.0
14.0	28.0	28.0	28.0	28.0	28.0	28.0	28.0/14.6m	28.0/15.4m		14.0
16.0	28.0	28.0	28.0	28.0	28.0	28.0	28.0	28.0	28.0/16.3m	16.0
18.0	28.0	28.0	28.0	28.0	28.0	28.0	28.0	28.0	28.0	18.0
20.0	28.0	28.0	28.0	28.0	28.0	28.0	28.0	28.0	28.0	20.0
22.0	28.0	28.0	28.0	28.0	28.0	28.0	28.0	28.0	28.0	22.0
24.0	28.0	28.0	28.0	28.0	28.0	28.0	28.0	28.0	28.0	24.0
26.0	28.0	28.0	28.0	28.0	28.0	28.0	28.0	28.0	28.0	26.0
28.0	28.0	28.0	28.0	28.0	28.0	28.0	28.0	28.0	28.0	28.0
30.0	28.0	28.0	28.0	28.0	28.0	28.0	28.0	28.0	28.0	30.0
32.0	28.0	28.0	28.0	28.0	28.0	28.0	28.0	28.0	28.0	32.0
34.0	28.0/33.9m	28.0	28.0	28.0	28.0	28.0	28.0	28.0	28.0	34.0
36.0		28.0	28.0	28.0	28.0	28.0	28.0	28.0	28.0	36.0
38.0		28.0	28.0	28.0	28.0	28.0	28.0	28.0	28.0	38.0
40.0		28.0/39.1m	28.0	28.0	28.0	28.0	28.0	28.0	28.0	40.0
42.0			28.0	28.0	28.0	28.0	28.0	28.0	28.0	42.0
44.0			28.0	28.0	28.0	28.0	28.0	28.0	28.0	44.0
46.0			28.0/44.3m	28.0	28.0	28.0	28.0	28.0	28.0	46.0
48.0				28.0	28.0	28.0	28.0	27.8	26.6	48.0
50.0				28.0/49.5m	28.0	27.4	26.4	25.4	24.2	50.0
52.0					26.2	25.3	24.3	23.2	21.9	52.0
54.0					24.3	23.4	22.3	21.1	19.9	54.0
56.0					23.6/54.7m	21.7	20.5	19.3	18.0	56.0
58.0						20.0	18.8	17.6	16.2	58.0
60.0						18.5/59.9m	17.3	16.0	14.6	60.0
62.0							15.9	14.6	13.2	62.0
64.0							14.7	13.3	11.8	64.0
66.0							14.1/65.1m	12.1	10.5	66.0
68.0								11.0	9.3	68.0
70.0								9.9	8.1	70.0
72.0								9.8/70.3m	7.7	72.0
ロープ掛数	2	2	2	2	2	2	2	2	2	ロープ掛数

# HEAVY LIFT

## ▶ロング主ブーム定格総荷重表

(単位:t)

ブーム長さ 作業半径(m)	90.0	96.0	102.0	108.0	ブーム長さ 作業半径(m)
14.0	98.0/15.0m	98.0/15.8m			14.0
16.0	98.0	98.0	84.0/16.6m	84.0/17.5m	16.0
18.0	98.0	98.0	84.0	84.0	18.0
20.0	98.0	97.5	84.0	84.0	20.0
22.0	89.9	87.4	84.0	81.9	22.0
24.0	81.0	78.8	75.9	73.8	24.0
26.0	73.5	71.5	68.7	66.7	26.0
28.0	66.9	65.1	62.3	60.5	28.0
30.0	61.1	59.4	56.8	55.1	30.0
32.0	56.0	54.4	51.8	50.3	32.0
34.0	51.5	49.9	47.5	46.0	34.0
36.0	47.4	45.9	43.5	42.1	36.0
38.0	43.5	42.3	40.0	38.7	38.0
40.0	39.9	39.0	36.7	35.5	40.0
44.0	33.8	33.2	31.1	30.0	44.0
48.0	28.9	28.3	26.4	25.3	48.0
52.0	24.7	24.2	22.4	21.4	52.0
56.0	21.2	20.7	18.9	18.0	56.0
60.0	18.2	17.6	15.9	15.0	60.0
64.0	15.4	14.8	13.3	12.4	64.0
68.0	13.0	12.4	10.9	10.0	68.0
72.0	10.8	10.2	8.9	8.0	72.0
76.0	8.9	8.3	7.0	6.2	76.0
80.0	7.2/80.1m	6.7			80.0
ロープ掛数	7	7	6	6	ロープ掛数

## ▶ロング補助シーブ定格総荷重表 (主ブームにフックなし)

(単位:t)

ブーム長さ 作業半径(m)	90.0	96.0	102.0	108.0	ブーム長さ 作業半径(m)
14.0	28.0/15.9m				14.0
16.0	28.0	28.0/16.7m	28.0/17.5m		16.0
18.0	28.0	28.0	28.0	28.0/18.5m	18.0
20.0	28.0	28.0	28.0	28.0	20.0
22.0	28.0	28.0	28.0	28.0	22.0
24.0	28.0	28.0	28.0	28.0	24.0
26.0	28.0	28.0	28.0	28.0	26.0
28.0	28.0	28.0	28.0	28.0	28.0
30.0	28.0	28.0	28.0	28.0	30.0
32.0	28.0	28.0	28.0	28.0	32.0
34.0	28.0	28.0	28.0	28.0	34.0
36.0	28.0	28.0	28.0	28.0	36.0
38.0	28.0	28.0	28.0	28.0	38.0
40.0	28.0	28.0	28.0	28.0	40.0
44.0	28.0	28.0	28.0	28.0	44.0
48.0	28.0	27.6	25.7	24.6	48.0
52.0	24.0	23.5	21.7	20.7	52.0
56.0	20.5	20.0	18.2	17.3	56.0
60.0	17.5	16.9	15.2	14.3	60.0
64.0	14.7	14.1	12.6	11.7	64.0
68.0	12.3	11.7	10.2	9.3	68.0
72.0	10.1	9.5	8.2	7.3	72.0
76.0	8.2	7.6	6.3		76.0
80.0	6.5/80.1m				80.0
ロープ掛数	2	2	2	2	ロープ掛数

# HEAVY LIFT

## ▶ラフティングジブ作動範囲図

### ■ラフティングジブ (ブーム角度86°)

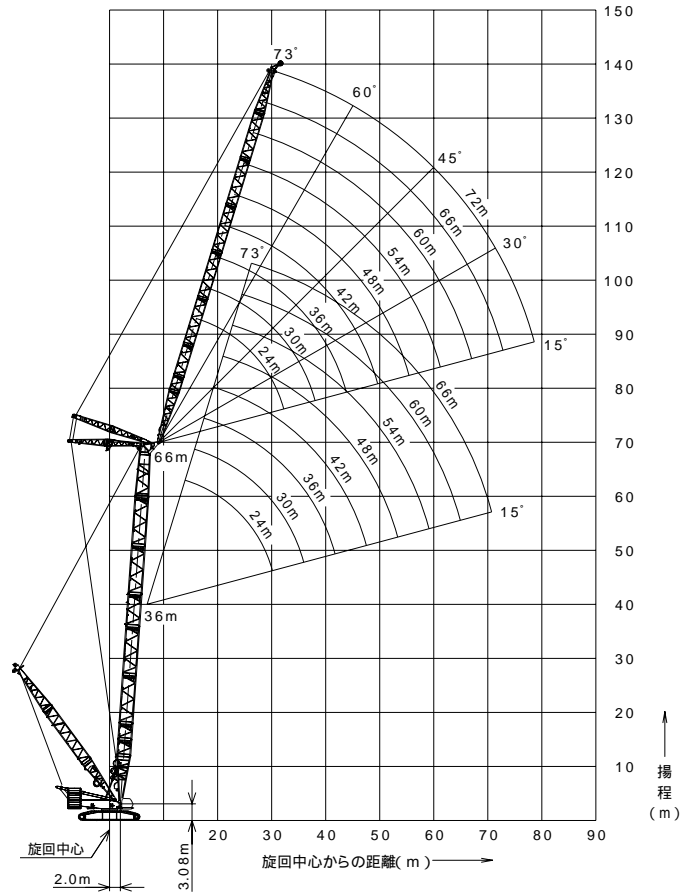

### ■ラフティングジブ (ブーム角度76°)

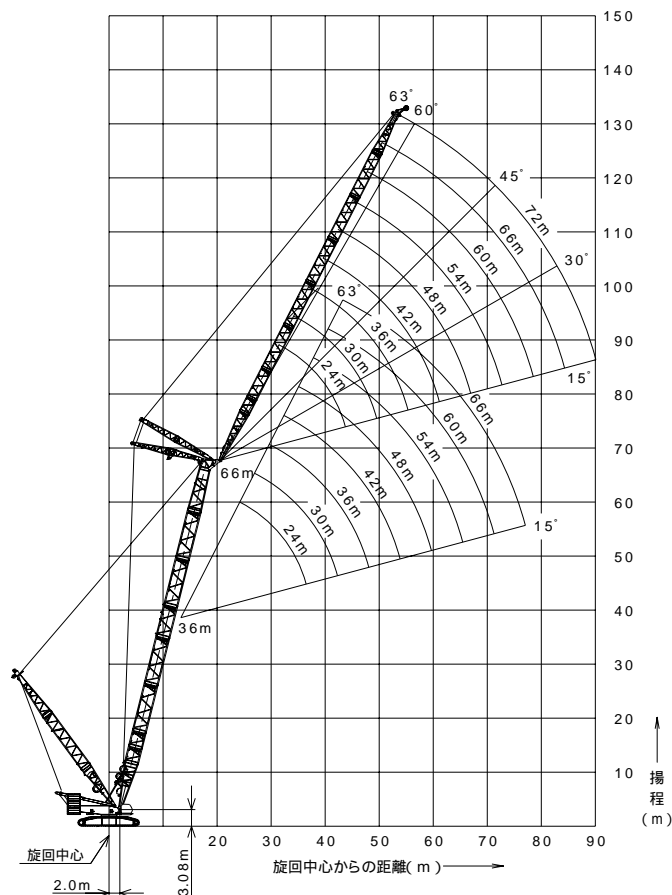

# HEAVY LIFT

## ▶ラフティングジブ定格総荷重表 (HLマストポイント半径16m)

(単位:t)

ブーム長さ(m)		36.0															ブーム長さ(m)		
ジブ長さ(m)		24.0			42.0			54.0			66.0			72.0			ジブ長さ(m)		
ブーム角度		86°	76°	66°	86°	76°	66°	86°	76°	66°	86°	76°	66°	86°	76°	66°	ブーム角度		
作業半径(m)	14.4	200.0															14.4		
	15.0	193.2															15.0		
	16.0	181.9															16.0		
	17.0	170.3															17.0		
	18.0	159.4															18.0		
	20.0	141.1				132.7											20.0		
	22.0	126.4				120.5											22.0		
	24.0	114.4				110.2			101.5								24.0		
	26.0	103.2	96.0			101.4			96.5								26.0		
	28.0	93.9	87.3			92.1			89.3			76.0					28.0		
	30.0	85.9	79.9			84.3			83.0			74.1			64.3		30.0		
	34.0		68.2			71.7	65.9			70.9			68.8			59.8	34.0		
	38.0			54.8		62.2	57.0			60.6			58.3			54.0	38.0		
	42.0			48.2		53.2	50.1			51.1	48.0			48.3		47.0	42.0		
	46.0					45.8	44.5	40.2		43.6	43.3			40.5	40.2		39.0	46.0	
	50.0						39.9	36.2		37.5	38.7			34.2	37.4		32.6	34.7	50.0
	54.0							32.6		32.4	34.8	30.3		29.0	33.5		27.3	33.0	54.0
	58.0							29.7		28.2	31.6	28.3		24.7	30.2		22.9	29.7	58.0
	62.0									28.8	25.7	21.1		27.4	22.5		19.2	26.9	62.0
	66.0										23.5	18.0		25.0	22.0		16.1	24.5	19.3
70.0										21.6	15.4		22.9	20.0		13.4	22.3	19.3	70.0
74.0													21.0	18.3		11.2	20.5	17.7	74.0
78.0														16.8			17.3	16.2	78.0
82.0														15.5			13.6	14.9	82.0
86.0																		13.7	86.0
ロープ掛数	16			12			8			6			5			ロープ掛数			

表中の太線で囲まれた荷重はダブルドラムを使用する必要があります。

(単位:t)

ブーム長さ(m)		42.0															ブーム長さ(m)			
ジブ長さ(m)		24.0			42.0			54.0			66.0			72.0			ジブ長さ(m)			
ブーム角度		86°	76°	66°	86°	76°	66°	86°	76°	66°	86°	76°	66°	86°	76°	66°	ブーム角度			
作業半径(m)	15.0	183.1/15.4m															15.0			
	16.0	175.9															16.0			
	17.0	166.1															17.0			
	18.0	156.3															18.0			
	20.0	140.0															20.0			
	22.0	125.4				116.7											22.0			
	24.0	113.5				106.9			94.1								24.0			
	26.0	102.7				98.4			93.1								26.0			
	28.0	93.4	85.4			91.2			86.7			74.9					28.0			
	30.0	85.5	78.2			83.8			80.6			73.6			61.0		30.0			
	34.0		66.6			71.3			70.4			66.9			58.9		34.0			
	38.0		57.8	52.5		61.8	55.4			60.6			58.3		54.0		38.0			
	42.0			46.1		53.2	48.7			51.1	46.5			48.3		47.0	42.0			
	46.0					45.6	43.2			43.5	42.1			40.4	38.8		38.9	46.0		
	50.0						38.7	34.0		37.3	37.6			34.0	36.2		32.4	33.3	50.0	
	54.0						35.0	30.9		32.2	33.8			28.8	32.4		27.0	32.0	54.0	
	58.0							28.0		27.8	30.6	25.5		24.4	29.2		22.6	28.7	58.0	
	62.0							25.6			27.8	24.1		20.7	26.5	20.8	18.9	26.0	62.0	
	66.0									25.5	22.0	17.6		24.1	20.5		15.7	23.6	17.3	66.0
	70.0										20.2	14.9		22.0	18.6		13.0	21.5	17.3	70.0
74.0										18.6				20.2	17.0		10.7	19.7	16.3	74.0
78.0														17.9	15.5			17.3	14.8	78.0
82.0															14.3			13.6	13.5	82.0
86.0																			12.3	86.0
90.0																			11.2	90.0
ロープ掛数	16			12			7			6			5			ロープ掛数				

表中の太線で囲まれた荷重はダブルドラムを使用する必要があります。

# HEAVY LIFT

(単位:t)

ブーム長さ(m)		48.0															ブーム長さ(m)
ジブ長さ(m)		24.0			42.0			54.0			66.0			72.0			ジブ長さ(m)
ブーム角度		86°	76°	66°	86°	76°	66°	86°	76°	66°	86°	76°	66°	86°	76°	66°	ブーム角度
作業半径(m)	16.0	167.4/16.2m															16.0
	17.0	160.1															17.0
	18.0	150.8															18.0
	20.0	135.8															20.0
	22.0	123.4			113.0												22.0
	24.0	112.6			103.6			90.2									24.0
	26.0	102.2			95.5			88.0									26.0
	28.0	92.9	83.4		88.4			84.1			67.3						28.0
	30.0	85.0	76.3		82.3			78.3			66.0			58.4			30.0
	34.0		65.0		70.9			68.5			62.9			56.3			34.0
	38.0		56.3		61.4	53.8		60.5			57.4			53.8			38.0
	42.0			43.9	52.9	47.3		50.9	45.0		48.2			46.9			42.0
	46.0			38.9	45.4	41.9		43.2	40.8		40.2			38.7			46.0
	50.0					37.5	31.9	37.0	36.4		33.7	32.9		32.1	32.0		50.0
	54.0					33.8	29.0	31.8	32.6		28.4	31.1		26.7	30.0		54.0
	58.0						26.2	27.4	29.5	23.6	24.0	28.2		22.2	27.1		58.0
	62.0						23.8		26.8	22.5	20.3	25.5		18.5	24.6		62.0
	66.0								24.6	20.4	17.1	23.2	16.2	15.3	22.4		66.0
	70.0									18.6	14.4	21.1	16.2	12.5	20.5	12.9	70.0
	74.0									17.1		19.4	15.0	10.2	18.8	12.9	74.0
78.0											17.8	13.7		17.2	12.7	78.0	
82.0												12.5		13.6	11.5	82.0	
86.0												11.6			10.4	86.0	
90.0															9.5	90.0	
ロープ掛数	16			12			8			5			5			ロープ掛数	

表中の太線で囲まれた荷重はダブルドラムを使用する必要があります。

(単位:t)

ブーム長さ(m)		54.0															ブーム長さ(m)
ジブ長さ(m)		24.0			42.0			54.0			66.0			72.0			ジブ長さ(m)
ブーム角度		86°	76°	66°	86°	76°	66°	86°	76°	66°	86°	76°	66°	86°	76°	66°	ブーム角度
作業半径(m)	17.0	154.3															17.0
	18.0	145.5															18.0
	20.0	131.2															20.0
	22.0	119.3			109.3												22.0
	24.0	109.4			100.2												24.0
	26.0	101.0			92.5			80.7									26.0
	28.0	92.4			85.7			78.2			63.1						28.0
	30.0	84.5	74.3		79.8			75.6			61.8			55.1			30.0
	34.0		63.2		69.9			66.5			58.7			52.9			34.0
	38.0		54.7		60.9	51.7		58.9			55.2			50.3			38.0
	42.0			41.4	52.5	45.8		50.5			47.8			46.5			42.0
	46.0			36.7	45.0	40.5		42.8	38.0		39.8			38.3			46.0
	50.0					36.2		36.5	34.8		33.3	31.5		31.7			50.0
	54.0					32.6	26.5	31.4	31.5		28.0	28.9		26.3	26.9		54.0
	58.0					29.6	24.3	27.0	28.4		23.6	26.1		21.8	25.1		58.0
	62.0						22.0		25.8	19.0	19.8	23.7		18.0	22.7		62.0
	66.0						20.1		23.5	18.2	16.7	21.6		14.8	20.6		66.0
	70.0									16.6	13.9	19.8	11.8	12.0	18.8		70.0
	74.0									15.2		18.2	11.8	9.7	17.1	8.8	74.0
	78.0									14.1		16.8	11.4		15.7	8.8	78.0
82.0												10.3		13.6	8.8	82.0	
86.0												9.3		11.6	8.3	86.0	
90.0												8.6			7.4	90.0	
94.0															6.7	94.0	
ロープ掛数	12			8			6			5			4			ロープ掛数	

表中の太線で囲まれた荷重はダブルドラムを使用する必要があります。



# HEAVY LIFT

(単位:t)

ブーム長さ(m)		60.0														ブーム長さ(m)
ジブ長さ(m)		24.0			42.0			54.0			66.0			72.0		ジブ長さ(m)
ブーム角度		86°	76°	66°	86°	76°	66°	86°	76°	66°	86°	76°	66°	86°	76°	ブーム角度
作業半径(m)	17.0	141.8/17.8m														17.0
	18.0	140.3														18.0
	20.0	126.7														20.0
	22.0	115.4			103.2											22.0
	24.0	105.9			97.0											24.0
	26.0	97.8			89.5			76.5								26.0
	28.0	90.8			83.0			74.2								28.0
	30.0	84.0			77.3			71.7			58.2					30.0
	34.0		61.4		67.8			64.4			55.3			49.4		34.0
	38.0		53.1		60.2			57.1			52.1			47.0		38.0
	42.0		46.6		51.9	43.2		49.8			47.1			44.3		42.0
	46.0			34.5	44.4	38.7		42.2	36.1		39.2			37.7		46.0
	50.0			30.7		34.9		36.0	32.5		32.7	29.7		31.1		50.0
	54.0					31.3		30.8	29.3		27.5	26.7		25.8	25.5	54.0
	58.0					28.4	21.7	26.4	26.6		23.0	24.1		21.3	23.1	58.0
	62.0						19.7		24.3	16.6	19.3	21.8		17.5	20.8	62.0
	66.0						18.0		22.4	15.6	16.1	19.8		14.3	18.8	66.0
	70.0								20.6	14.1	13.4	18.0	9.5	11.5	17.0	70.0
	74.0									12.8		16.5	9.5	9.2	15.5	74.0
	78.0									11.7		15.1	9.1	7.1	14.1	78.0
82.0											14.1	8.1		12.9	82.0	
86.0												7.2		11.6	86.0	
90.0												6.5			90.0	
ロープ掛数	12			8			6			5			4		ロープ掛数	

表中の太線で囲まれた荷重はダブルドラムを使用する必要があります。

(単位:t)

ブーム長さ(m)		66.0														ブーム長さ(m)
ジブ長さ(m)		24.0			42.0			54.0			66.0			72.0		ジブ長さ(m)
ブーム角度		86°	76°	66°	86°	76°	66°	86°	76°	66°	86°	76°	86°	76°	ブーム角度	
作業半径(m)	18.0	131.7/18.5m													18.0	
	20.0	122.2													20.0	
	22.0	111.4			95.3										22.0	
	24.0	102.3			91.5										24.0	
	26.0	94.5			86.5			71.3							26.0	
	28.0	87.8			80.3			68.1							28.0	
	30.0	82.0			74.8			66.6			55.1				30.0	
	34.0		57.5		65.6			61.6			52.2			46.4		34.0
	38.0		50.8		58.2			55.2			49.0			44.0		38.0
	42.0		45.0		50.8	40.1		48.7			45.7			41.4		42.0
	46.0				43.5	35.9		41.2	33.4		38.2			36.7		46.0
	50.0			28.0		32.3		35.1	29.9		31.9			30.3		50.0
	54.0			25.4		29.3		30.0	26.9		26.7	24.4		25.0	23.4	54.0
	58.0					26.8	18.4	25.7	24.4		22.4	21.9		20.6	20.9	58.0
	62.0						16.6		22.2		18.7	19.7		16.9	18.8	62.0
	66.0						15.0		20.3	11.8	15.5	17.8		13.7	16.9	66.0
	70.0						13.7		18.7	11.4	12.8	16.1	10.9	15.2	15.2	70.0
	74.0									10.2		14.7	8.6	13.7	13.7	74.0
	78.0									9.1		13.4	6.5	12.4	12.4	78.0
	82.0									8.3		12.3		11.2	11.2	82.0
86.0													10.2	10.2	86.0	
90.0													9.0	9.0	90.0	
ロープ掛数	12			8			6			4			4		ロープ掛数	

表中の太線で囲まれた荷重はダブルドラムを使用する必要があります。

## ▶分解時の寸法・質量

- 記載の数値は参考値です。
- 一般公道での輸送に際しては関係法規を遵守してください。

## ■本体

名称	寸法 (幅×高さ×長さ) mm	質量 kg
上部本体 ・マスト無し ・上下分解装置(上部側)を含む		32,000
カーボディ ・下部トランスリフタ、 上下分解装置(下部側)を含む		22,610
クローラ ・シューを含む		40,000
クレーンマスト		12,460
ベースカウンタウエイト		20,000
カウンタウエイト	2,450×480×1,900	10,000/1個
ベースカーボディウエイト(リンク付き)	2,960×460×2,390	5,400
ベースパレットウエイト(リンク付き)	2,450×1,020×7,300	11,000

## ■アタッチメント

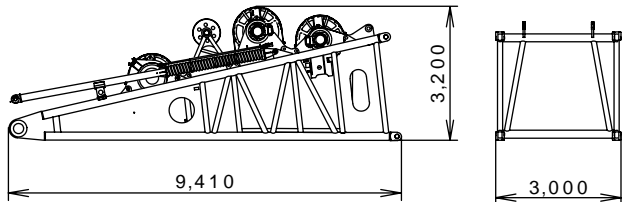
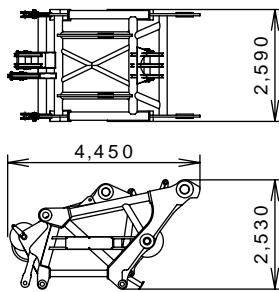
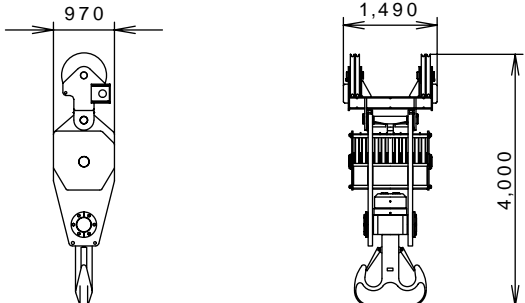
名称	寸法 (幅×高さ×長さ) mm	質量 kg
9m下部ブーム ・巻上1ドラム(ロープ付) 巻上2ドラム(ロープ付) 起伏2ドラム(ロープ付) ガイドシーブ ブームバックストップを含む		28,440
1m上部ブーム(ラフティング)		5,520
1m上部ブーム(ヘビーデューティ)	2,600×1,510×3,390	4,910
3m中間ブーム(3mガイドライン×4本付き)	3,000×2,840×3,220	2,300
6m中間ブーム(6mガイドライン×4本付き)	3,000×2,840×6,220	3,760
9m中間ブーム(9mガイドライン×4本付き)	3,000×2,840×9,220	5,100
8m中間テーパーブーム(8mガイドライン×2本付き)	3,000×2,840×8,220	5,150
9m下部HLマスト	3,050×2,530×9,360	13,700
12m中間HLマスト(ガイドライン付き)	2,990×2,340×12,240	5,650
9m上部HLマスト(ガイドライン付き)	2,860×2,620×10,850	10,080
つり下げシーブ	760×2,130×2,760	2,010
5mロング中継ブーム	2,490×2,230×5,180	1,790
10m下部ラフティングジブ	2,490×1,990×10,290	3,780
8m上部ラフティングジブ 兼 ロング上部ブーム	2,490×1,990×8,670	3,690
3m中間ラフティングジブ	2,490×2,060×3,140	890
6m中間ラフティングジブ	2,490×2,060×6,140	1,470
9m中間ラフティングジブ	2,490×2,060×9,140	2,100
リヤ下部ストラット	2,590×1,620×6,820	1,990
リヤ上部ストラット	1,530×1,390×7,060	2,410
フロント下部ストラット	1,640×1,330×7,460	1,840
フロント上部ストラット	1,530×2,090×8,080	3,040
補助シーブ	1,130×910×2,380	650
300tフック		7,820
200tフック	970×3,120×1,320	7,050
120tフック	1,000×2,370×960	4,500
70tフック	900×2,120×760	3,100
40tフック	900×1,810×700	2,000
14tボールフック	450×1,770	830



### 感じています、新鮮!

小さな風。きっと最初はそこから始まる。  
その風が共鳴しあい大きなニーズに成長する。  
私たちは小さな風に耳を澄ます、感じとる。  
人にもっと優しい技術の道を切り拓くために。  
新しさと提案に満ちたマシンづくりを。  
新風を感じ、帆いっぱい捉え、また新たな旋風を呼ぶ。  
マシンと人間の新しい関係が生まれる。

“Feelin' Fresh!” は、何よりお客さまの現場を重視する  
「ユーザー現場主義」の姿勢を貫くことを誓う  
私たちのコーポレート・メッセージです。

つり上げ荷重5t以上の移動式クレーン運転には「移動式クレーン運転士免許証」、クラムセル作業には「車両系建設機械(整地ほか)運転技能講習修了証」、基礎工事には「車両系建設機械(基礎用)運転技能講習修了証」がそれぞれ必要です。

# コベルコクレーン株式会社

www.kobelco-cranes.com

東京本社 / 〒141-8626 東京都品川区東五反田2-17-1 ☎03-5789-2130

北海道 ☎011-377-1902・宮城 ☎0223-24-1482・東京 ☎03-5789-2125

市川 ☎047-328-4311・北陸 ☎076-682-6390・東海 ☎052-603-1205

近畿 ☎06-6414-2103・中国 ☎082-810-3880・九州 ☎092-503-3329

■お問い合わせは……